

UNIVERZÁLIS TERASZ+TETŐHOSSZABBÍTÓ

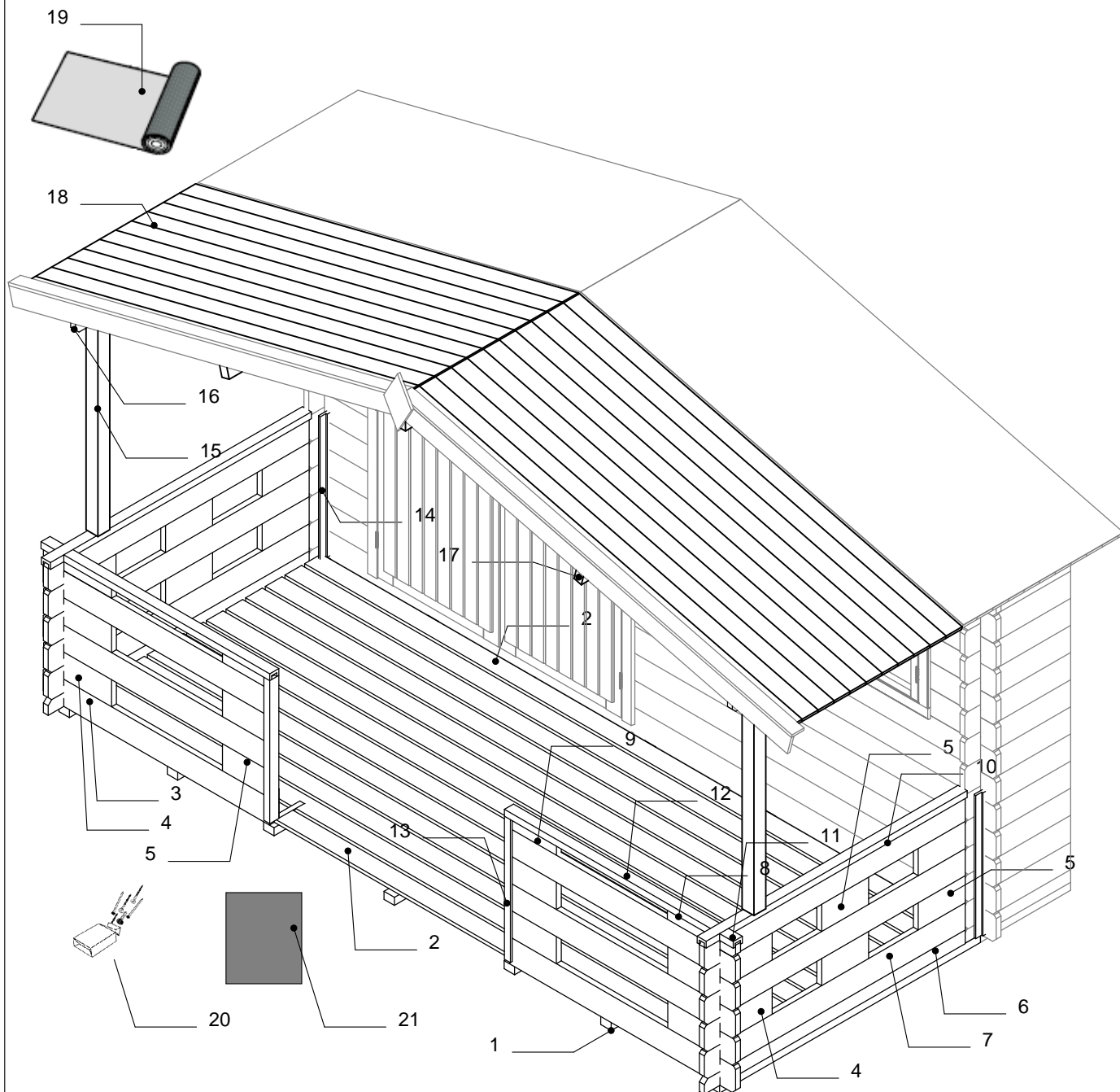

21	1	AUFBAUANLEITUNG	ÉPÍTÉSI ÚTMUTATÓ		
20	1	BEV. MATERIAL	CSAVARCSOMAG		
19	1	DACHPAPPE	KÁTRÁNYPAPÍR	0,9x10m	
18	22	DACHBRETTER	TETŐDESZKA	15x99	2350
17	3	DACHPFETTE	GERENDA	43x145	1900
16/44mm	2	WANDBOEHLE	FALDESZKA	44x143	1421
16/28mm	2	WANDBOEHLE	FALDESZKA	28x143	1413
15	2	PFOSTEN	OSZLOP	68x68	1235
14	4	PROFILLATTE	TAKARÓLÉC	18x68	712
13	2	J-PROFIL	J-PROFIL	52x34	712
12	2	J-PROFIL	J-PROFIL	52x34	1185
11	2	J-PROFIL	J-PROFIL	52x34	80
10	2	J-PROFIL	J-PROFIL	52x34	1500
9	2	WANDBOEHLE	FALDESZKA	28x67,5	270
8	2	WANDBOEHLE	FALDESZKA	28x67,5	390
7	6	WANDBOEHLE	FALDESZKA	28x143	1500
6	2	WANDBOEHLE FEDER	FÉL FALDESZKA	28x76	1500
5	12	WANDBOEHLE	FALDESZKA	28x143	270
4	8	WANDBOEHLE	FALDESZKA	28x143	390
3	6	WANDBOEHLE	FALDESZKA	28x143	1300
2	13	TERRASSENBRETT	TERASZDESZKA	18x96	3740
1	7	FUßBODENBALKEN	IMPREGNÁLT STAFNI	40x60	1500
POS NR/POZANZAHL/DB		BESCHREIBUNG	MEGNEVEZÉS	ABMESSUNG/KER.M.	LÄNGE/HOSSZ
050208					HP0793

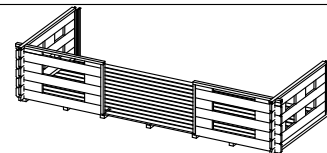
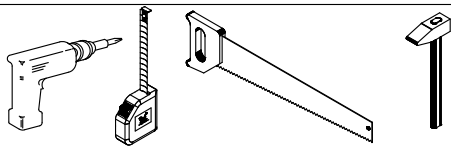

1.

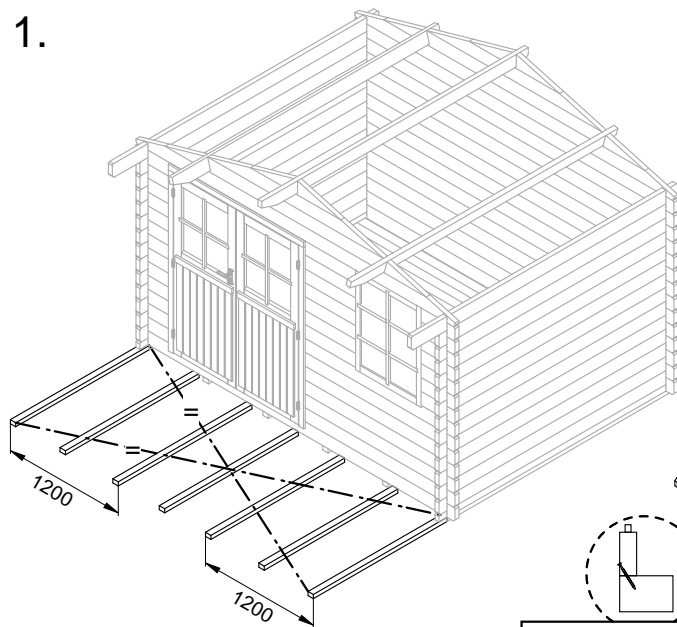

2.

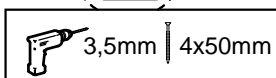
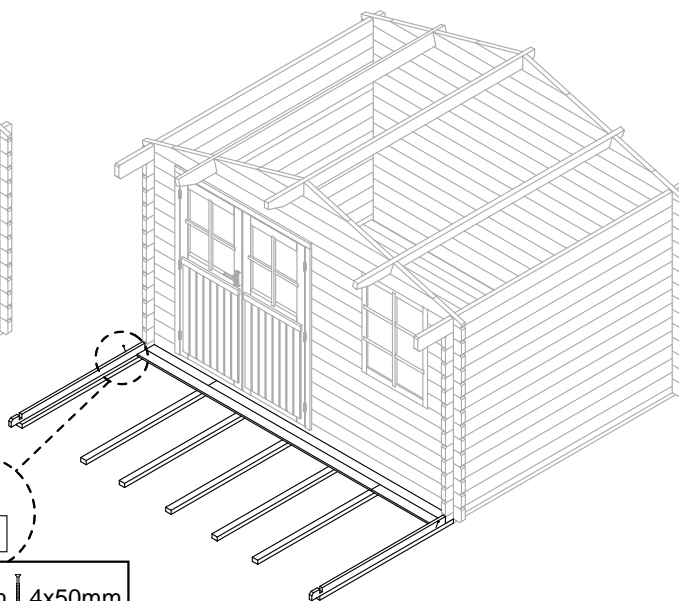

3.

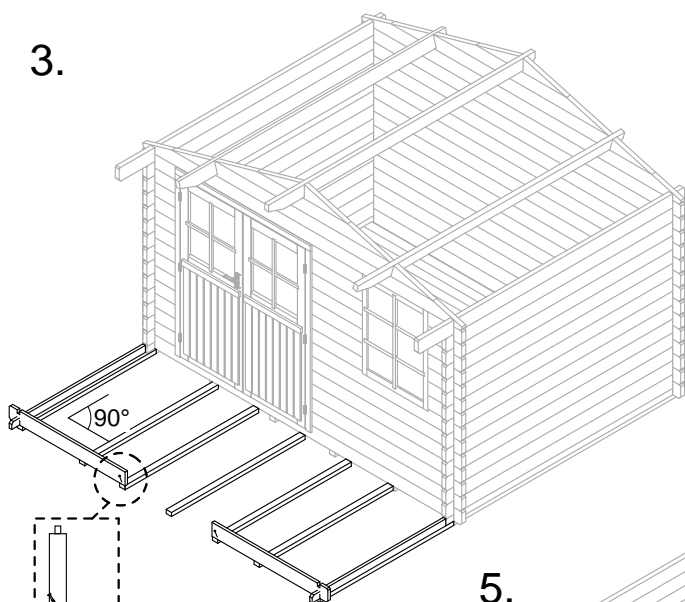

4.

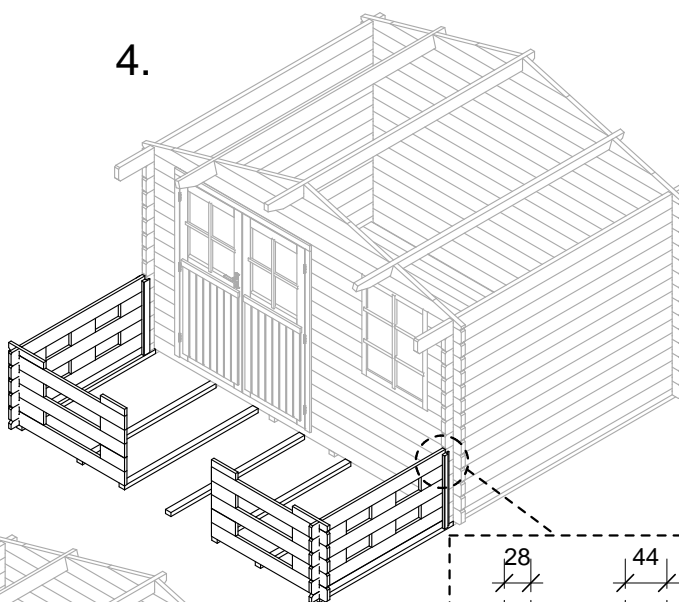

5.

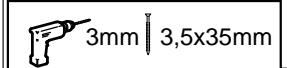
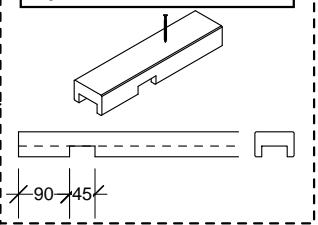
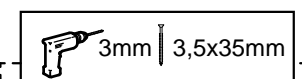
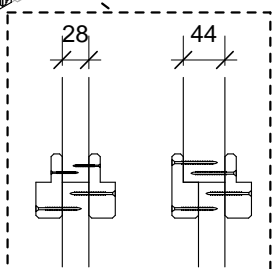
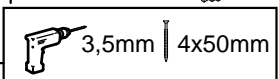
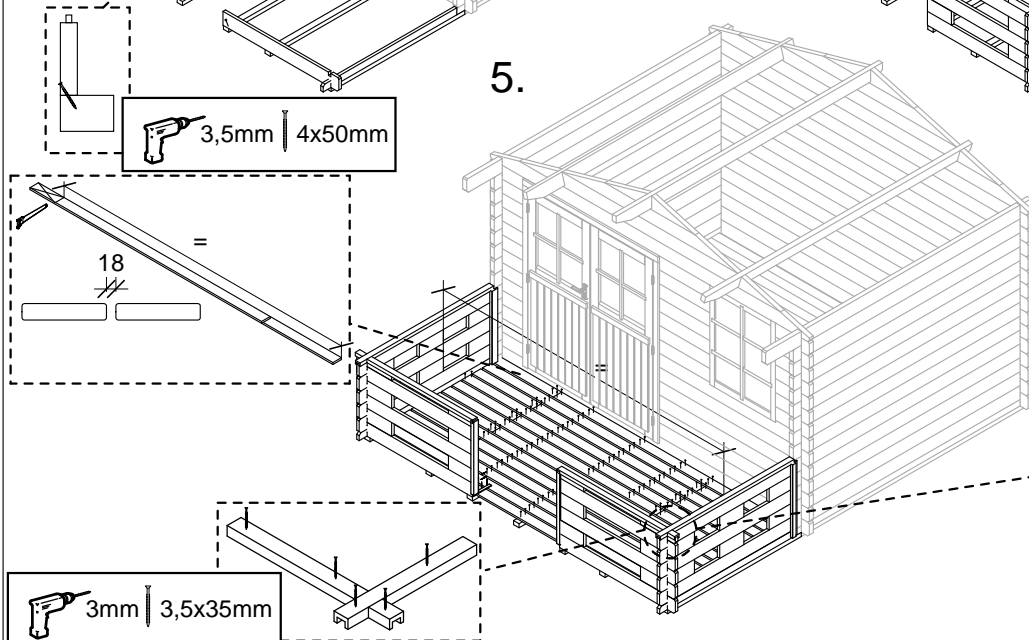

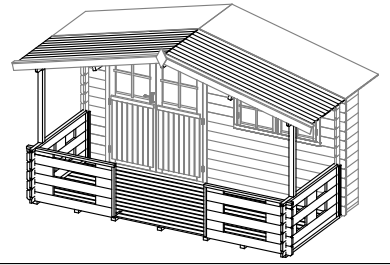
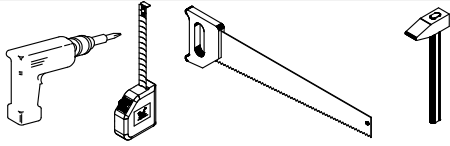

6.

3,5mm | 4x50mm

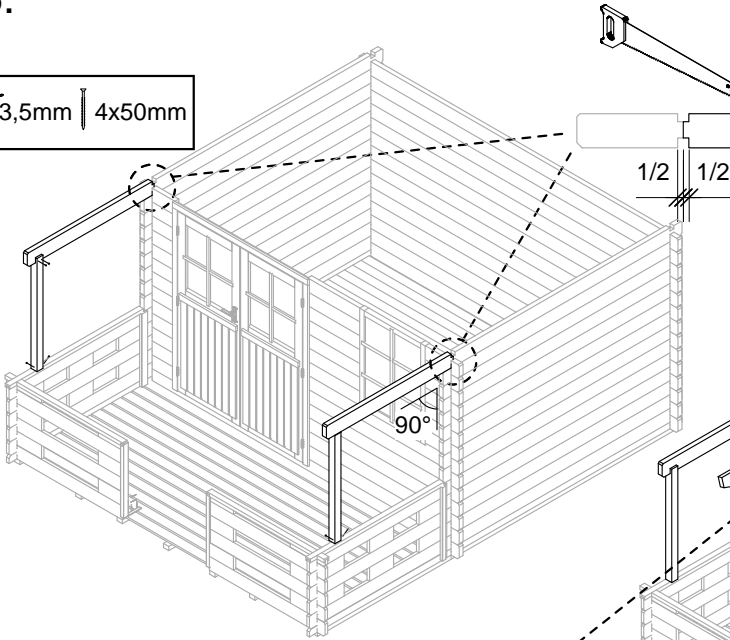

7.

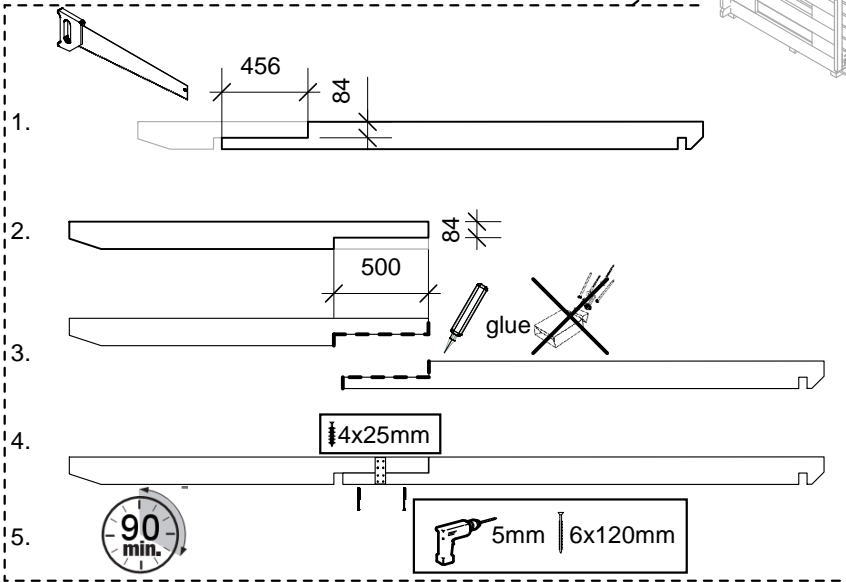
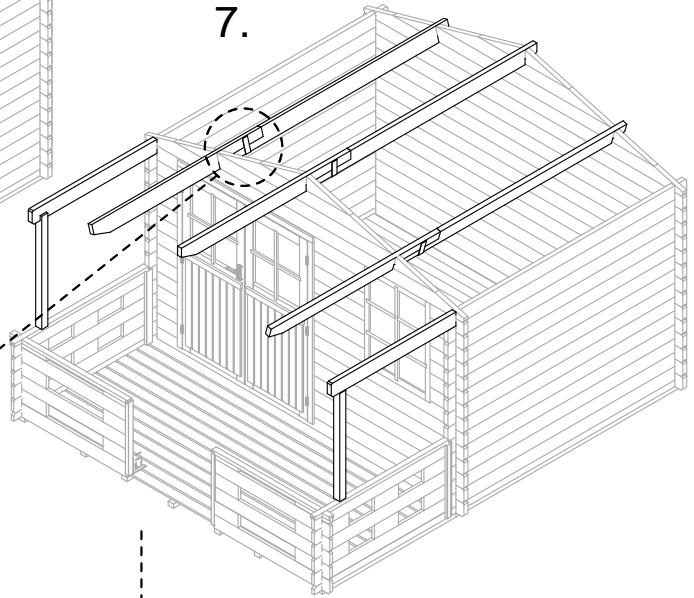

8.

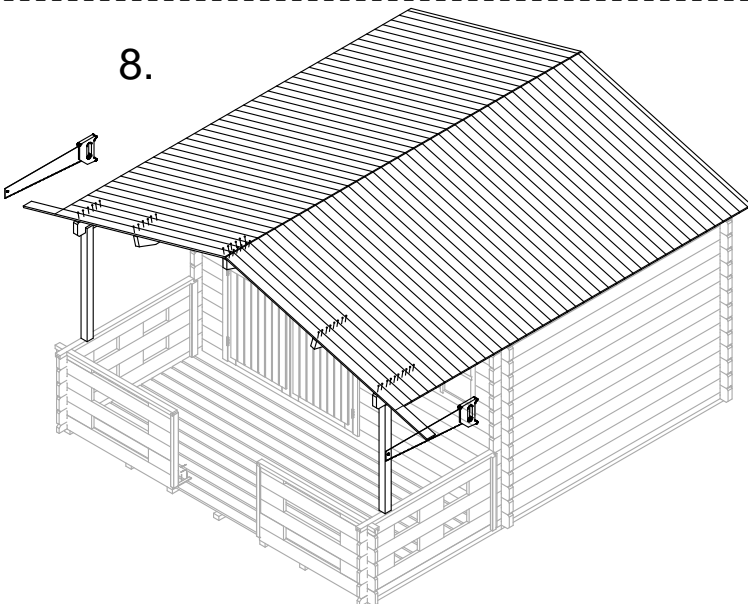

9.

